



S&E Spa Electrics®

LiTYARD®

Outdoor Lighting System

LiTYARD
OUTDOOR LIGHTING SYSTEM

**INSTALLATION &
OWNER'S MANUAL**

CONTENTS

BEFORE YOU START	1
READ THIS FIRST	2
WHAT'S INCLUDED	3
CONTROLLER INSTALLATION	4
RF BRIDGE INSTALLATION	5
WIRING EXAMPLES	8
QUICK SETUP PROCESS	11
LIT YARD RF BRIDGE LED STATUS	12
HANDSET PAIRING	12
REMOTE HANDSET OPERATION	13
TROUBLE SHOOTING - REMOTE HANDSET	13
FCC COMPLIANCE STATEMENT	14
SPECIFICATIONS	14

BEFORE YOU START

LIGHT REQUIREMENTS

ENSURE ALL YOUR LIGHTS ARE LIT YARD COMPATIBLE BEFORE INSTALLATION.
THE LIT YARD SYSTEM IS NOT COMPATIBLE WITH MULTI COLOUR PRODUCTS.

READ THIS FIRST

Read and follow the safety instructions listed below and other basic safety precautions before installation or operation of this transformer and other associated equipment.

This power unit is specifically designed to supply 12 VAC to landscape, fountain, swimming pool and spa luminaires.

Installation must comply with provisions of the National Electrical Code, ANSI/NFPA 70, including those in Article 680 - Swimming Pools, Spas, Fountains and Water Features.

CAUTION: for use only on a branch circuit protected by a class a type ground fault circuit interrupter.

Power supplies are for outdoor use only. Not for use with an extension cord.



WARNING

If the installation requires running wire through building structure, special wiring methods are needed.

Do not submerge.

Do Not exceed the maximum ratings of individual components, wiring devices and current carrying capacity of conductors.

PRODUCT SUPPORT & INFORMATION

VISIT: WWW.SPAELECTRICS.COM

WHAT'S INCLUDED

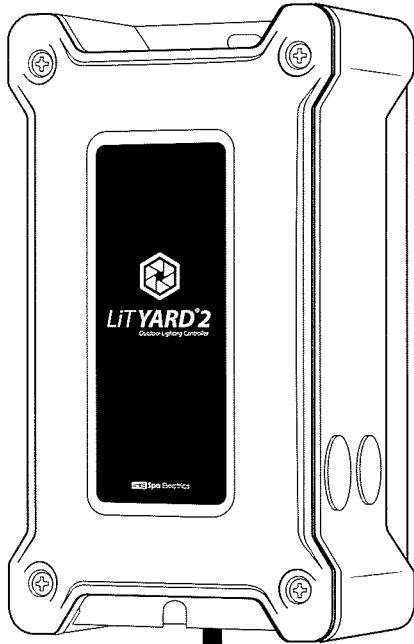

LiT YARD 2
Controller

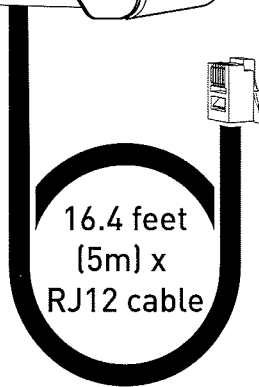

16.4 feet
(5m) x
RJ12 cable

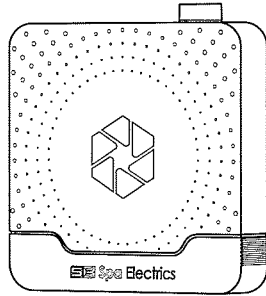

LiT YARD RF Bridge

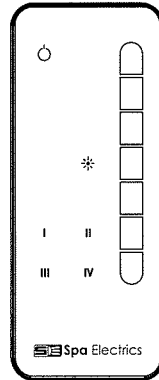

REMOTE HANDSET

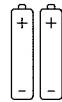

x 2 'AAA'
BATTERIES

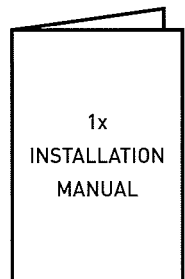
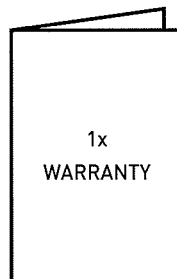

MOUNTING THE CONTROLLER

POSITIONING

ENSURE THE LIT YARD 2 OUTDOOR LIGHTING CONTROLLER IS WALL MOUNTED AT LEAST 20" (500mm) ABOVE GROUND AND IN A SERVICEABLE LOCATION.

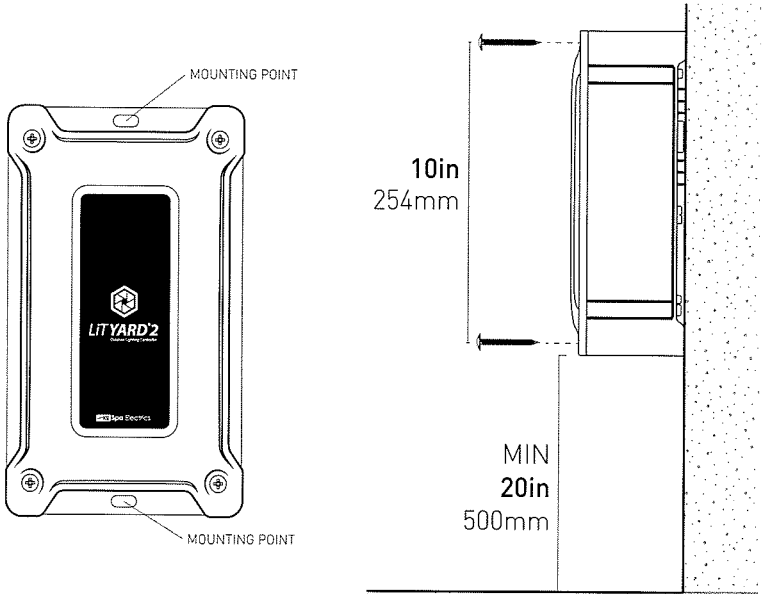

SCREW KIT INCLUDED FOR LIT YARD 2



NOTE

This product has been designed for use with PVC/Flexible conduit, it is not intended to be used with metallic conduit. Connections/hubs need to be UL Listed, weather/rain-tight and suitable for the application. All conduits should be adequately supported to prevent excessive stress on the enclosure.

MOUNTING THE RF BRIDGE

POSITIONING

WHEN FINDING A LOCATION TO MOUNT THE Li YARD 2 RF BRIDGE, THERE ARE SOME FACTORS THAT WILL IMPROVE THE CONNECTIVITY OF YOUR RF BRIDGE TO YOUR REMOTE HANDSET.

THE RF BRIDGE SHOULD BE MOUNTED: - IN AN ELEVATED POSITION.
- OUTSIDE OF ENCLOSURES.
eg. PUMP HOUSES OR GARDEN SHEDS.

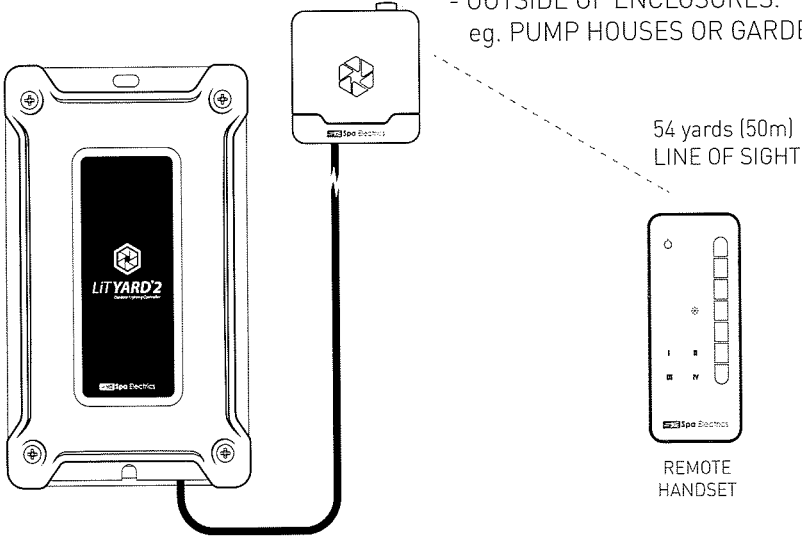

MINIMIZING THE NUMBER OF OBSTRUCTIONS BETWEEN THE RF BRIDGE AND THE REMOTE CONTROLLER WILL IMPROVE THE CONNECTIVITY BETWEEN THE DEVICES. MATERIALS SUCH AS TIN, STEEL AND CONCRETE CAN HAVE A DETRIMENTAL AFFECT ON THE RF BRIDGE SIGNAL TO THE REMOTE CONTROLLER.

THE REMOTE HANDSET SHOULD BE WITHIN A 54 yard (50m) LINE OF SIGHT OF THE RF BRIDGE.

1 INSTALLING THE KEYHOLE SCREW

THE RF BRIDGE USES A KEYHOLE HOOK ARRANGEMENT FOR MOUNTING. FASTEN THE SCREW INTO THE WALL MATERIAL UNTIL THE SCREW HAS 1/4-1/2 inches (7-11mm) STILL EXPOSED FROM THE WALL.

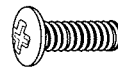
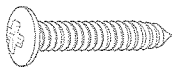

1/4-1/2 in
7-11mm

MOUNTING THE RF BRIDGE

2

ATTACHING RF BRIDGE TO KEY HOLE SCREW

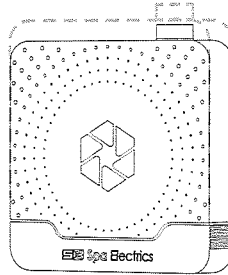
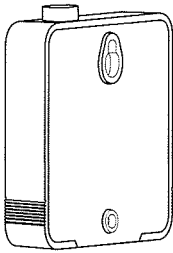

1. SLIDE THE RF BRIDGE OVER THE MOUNTING SCREW USING THE KEYHOLE ON THE REAR OF THE UNIT.
2. LOWER THE RF BRIDGE OVER THE MOUNTING SCREW TO ENGAGE THE LOCKING PORTION OF THE KEYHOLE.

3

INSTALLING THE LOWER MOUNTING SCREW

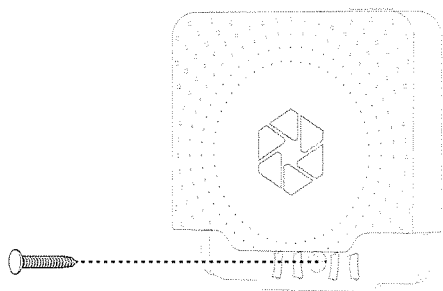
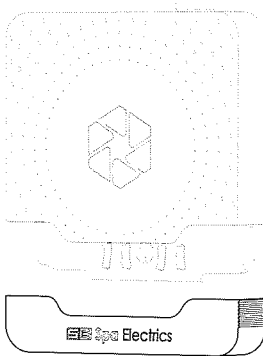

1. REMOVE THE LOWER COVER ON THE RF BRIDGE TO EXPOSE THE LOWER MOUNTING HOLE.
2. FASTEN A SCREW THROUGH THE LOWER MOUNTING HOLE INTO THE WALL MATERIAL.



NOTE

WHEN MOUNTING THE RF BRIDGE TO CONCRETE OR BRICK, IT IS ADVISED TO FIRST USE THE RF BRIDGE TO MARK THE MOUNTING HOLE POSITION AND REMOVE THE RF BRIDGE BEFORE DRILLING THE PILOT HOLE.

CABLE CONNECTIONS

4 CONNECTING THE RF BRIDGE

1. REMOVE THE COVER AND INSERT THE RJ12 CABLE INTO THE RF BRIDGE

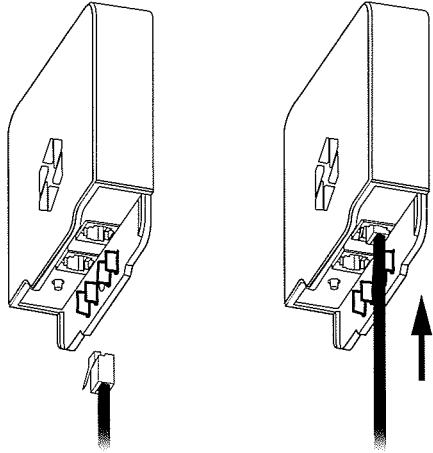

2. INSERT THE RJ12 CABLE INTO THE CABLE GUIDE SLOT ON THE LOWER COVER OF THE RF BRIDGE.

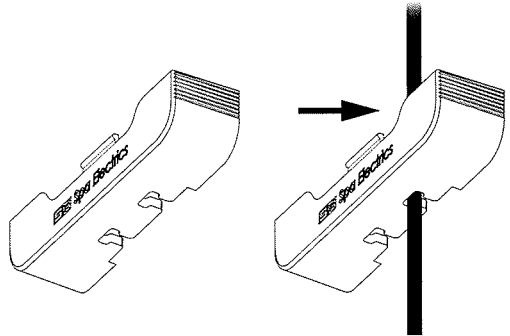

3. RE-INSTALL THE LOWER COVER ON TO THE RF BRIDGE.

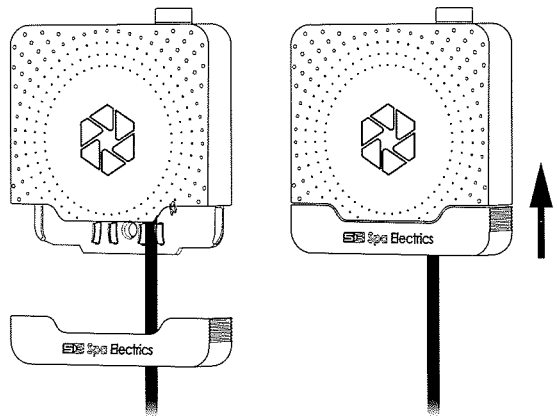

WIRING - EXAMPLE 1

INDEPENDENT WIRING (MAX 4 LIGHTS)

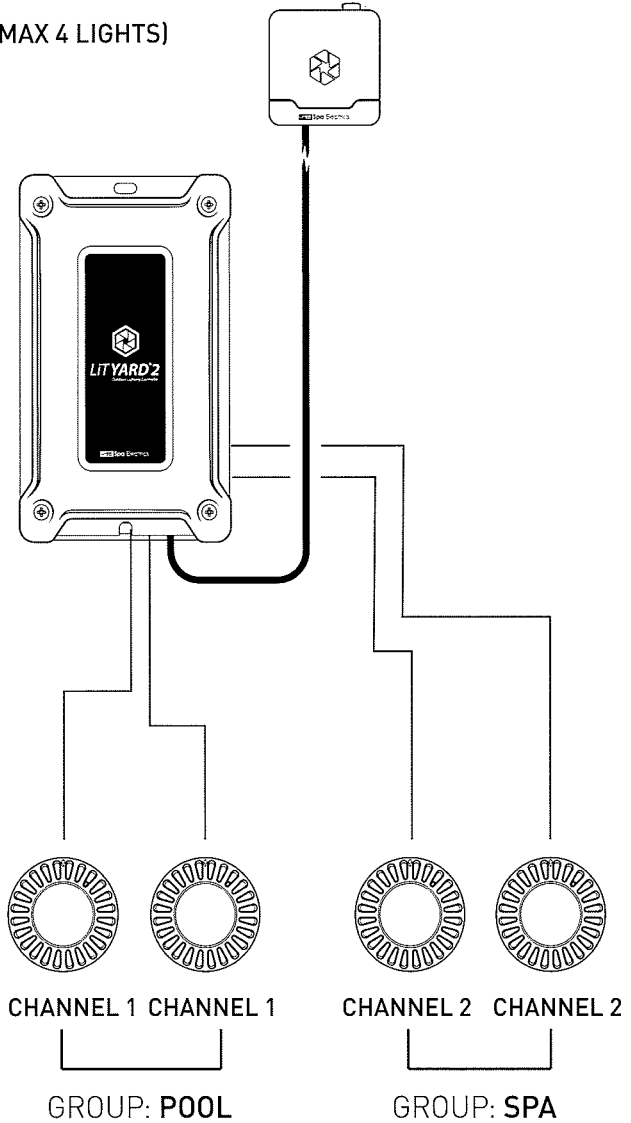

NOTE

POOL & SPA CHANNELS CAN BE CONTROLLED INDEPENDENTLY OR AS A GROUP VIA THE REMOTE.

WIRING - EXAMPLE 2

BRANCH WIRING (MAX 6 LIGHTS)

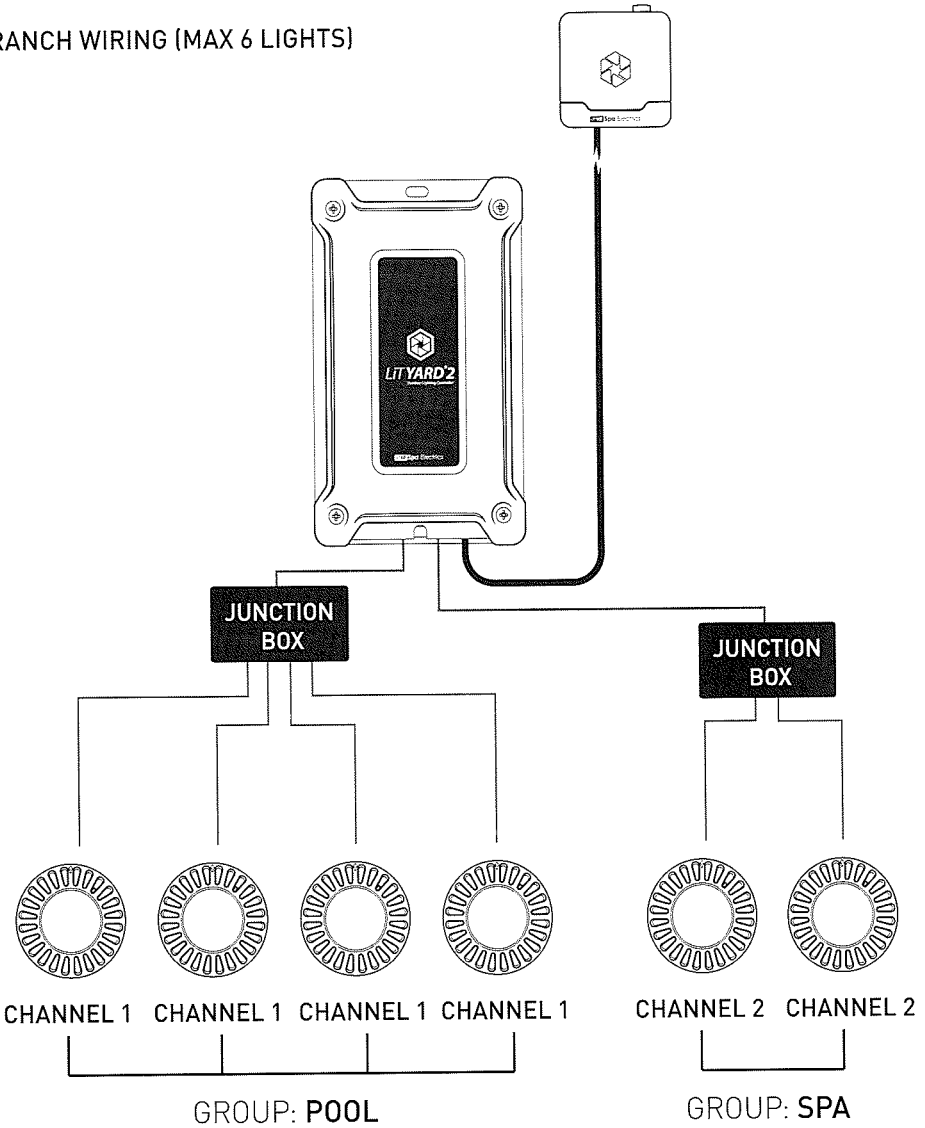

NOTE

POOL & SPA CHANNELS CAN BE CONTROLLED INDEPENDENTLY OR AS A GROUP VIA THE REMOTE.

WIRING - EXAMPLE 3

MULTIPLE LIT YARD CONTROLLERS

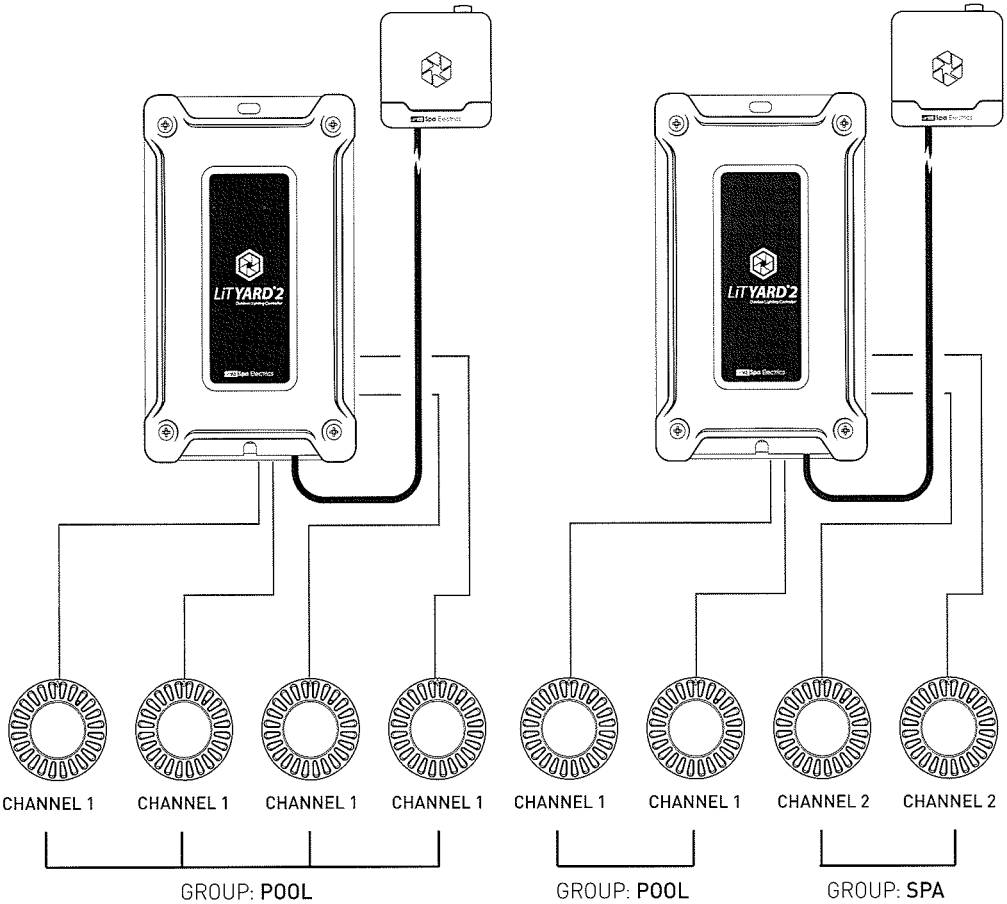

LARGER INSTALLATION?

THE LIT YARD SYSTEM CAN SUPPORT A MAXIMUM OF 10 CONTROLLERS. EACH LIT YARD 2 CONTROLLER REQUIRES ITS OWN RF BRIDGE.

QUICK SETUP PROCESS

BEFORE YOU START

- The Remote Handset is designed to be used with the Spa Electrics LiT YARD 2 Controller. (Please check product labeling to ensure it is suitable)
- For Retro-fit installations, where existing transformers have been hardwired; a suitably qualified electrician must disconnect the transformers and terminate with a plug top connection in accordance with NEC and State Electrical Codes for hardwired installations.

LIT YARD 2 QUICK SETUP

The Remote Handset has a QUICK SETUP feature to program LiT YARD 2 for operation.

STEP 1

Ensure the lights have been **OFF** for a minimum of **30 seconds**, then turn the system **ON** using the Remote Handset.

STEP 2

Press the following static colors in order with a **1 second** pause between each press.

- 2a. **WHITE**
- 2b. **RED**
- 2c. **GREEN**

If performed correctly, the lights will illuminate **GREEN**.

Confirm correct operation by selecting a different color using the Remote Handset.

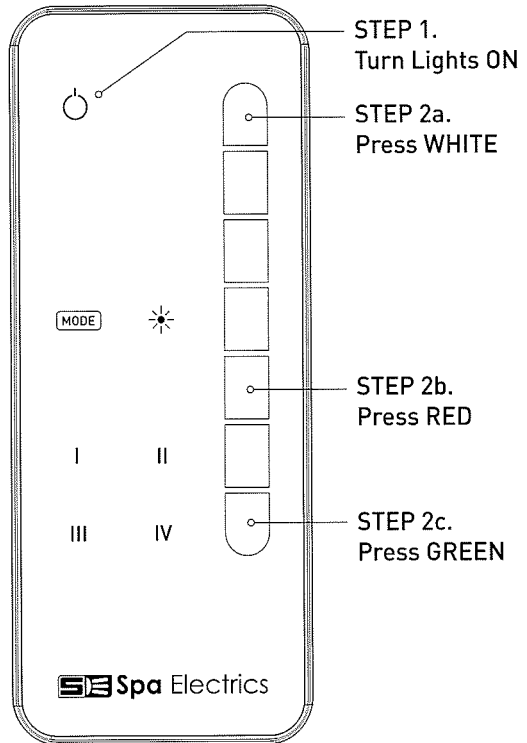

LIT YARD RF BRIDGE LED STATUS

THE FRONT OF THE LIT YARD RF BRIDGE HAS AN LED INDICATOR.
PLEASE SEE BELOW FOR THE STATUS OF DIFFERENT COLORS INDICATED.

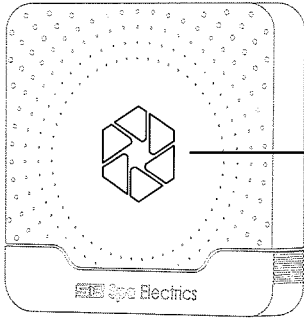

SOLID GREEN —————	INDICATES THE LIT YARD RF UNIT IS POWERED UP
SOLID RED —————	INDICATES THE LIT YARD RF BRIDGE IS READY FOR PAIRING TO A REMOTE HANDSET
FLASHING RED - - - - -	INDICATES THE LIT YARD RF BRIDGE IS PAIRED TO A REMOTE HANDSET. FOLLOW "HANDSET PAIRING - MEMORY RESET" TO CONNECT A NEW HANDSET.

HANDSET PAIRING

Your Remote Handset should come pre-assigned to the LiT YARD RF Bridge. However if it is not paired, please follow the below instructions:

STEP 1: Press the pairing button on the base of the LiT YARD RF Bridge. The LiT YARD RF Bridge will now switch to learning mode, indicated by the flashing red LED.

STEP 2: Within 1 second, press any of the buttons on the Remote Handset. The Remote Handset is now assigned to the LiT YARD RF Bridge

MEMORY RESET: To reset the receiver memory, press and hold the button on the bottom of the LiT YARD RF Bridge for 10 seconds. The LED indicator will flash fast initially, then flash slow indicating the memory has been erased. Once erased, release the Button and complete steps 1 & 2 to program the Remote Handset.

TO ACCESS THE PAIRING BUTTON ON THE LIT YARD RF BRIDGE

1: Slide down the Bottom cover of the LiT YARD RF Bridge.

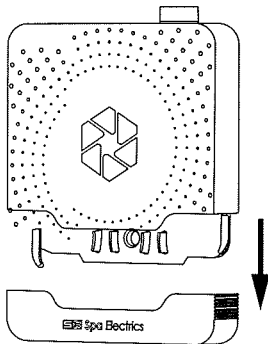

2: The button is located to the left of the cable inputs.

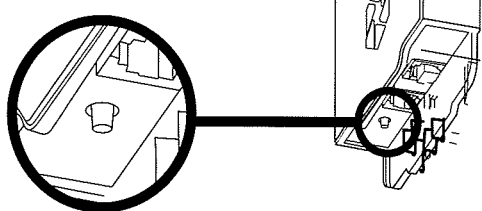

REMOTE HANDSET OPERATION

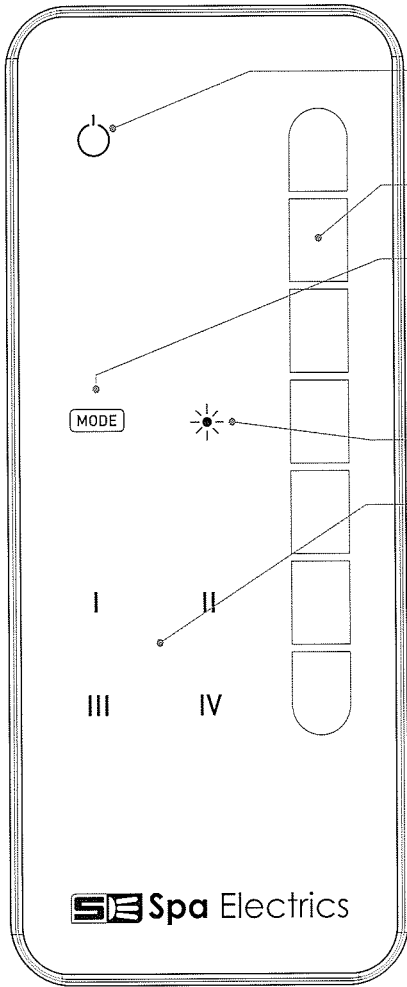

POWER BUTTON
WITH LED INDICATOR

7 STATIC COLOURS

CHANNEL SELECTION

LED INDICATOR COLOUR

BLUE - POOL & SPA

GREEN - POOL ONLY

RED - SPA ONLY

BRIGHTNESS CONTROL

4 MULTI-COLOUR MODES

I - Oceanic Views

II - Transcendence

III - Outback Australia

IV - Spring Equinox

NOTE: The Remote Handset requires an initial button press to 'wake-up' the handset. Press the power button once, and the LED indicator light will illuminate to signal it is active and the Remote Handset is 'awake'.

After 2 minutes of inactivity, the Remote Handset will return to 'sleep mode'.

TROUBLE SHOOTING - REMOTE HANDSET

CONDITION

CORRECTIVE ACTION

Flashing power indicator on Remote Handset

Low Battery - Replace 2 x AAA Batteries in Remote Handset

Intermittent communication between Remote Handset and the RF Bridge

- Reset RF Bridge memory (see 'Handset Pairing')
- Pair Remote Handset to RF Bridge (see 'Handset Pairing')

FCC COMPLIANCE STATEMENT

Warning: Changes or modifications not expressly approved by the party responsible for compliance could void the user's authority to operate the equipment. This device complies with part 15 of the FCC rules.

Operation is subject to the following two (2) conditions:

- (1) This device may not cause harmful interference, and
- (2) This device must accept any interference received, including interference that may cause undesired operation.

Note: This equipment has been tested and found to comply with the limits for a Class B digital device, pursuant to part 15 of the FCC Rules. These limits are designed to provide reasonable protection against harmful interference in a residential installation. This equipment generates, uses and can radiate radio frequency energy and, if not installed and used in accordance with the instructions, may cause harmful interference to radio communications. However, there is no guarantee that interference will not occur in a particular installation. If this equipment does cause harmful interference to radio or television reception, which can be determined by turning the equipment off and on, the user is encouraged to try to correct the interference by one or more of the following measures:

- Reorient or relocate the receiving antenna.
- Increase the separation between the equipment and receiver.
- Connect the equipment into an outlet on a circuit different to that to which the receiver is connected.
- Consult the dealer or an experienced radio / TV technician for help.

The device radiates radio frequency energy at a level below the United States FCC radio frequency exposure limits. Nevertheless, this device should be used in such a manner that the potential for human contact during normal operation is minimized. For body worn operation, this device has been tested and meets FCC RF exposure guidelines when used with accessory that contains no metal. Use of other accessories may not ensure compliance with FCC RF exposure guidelines.

SPECIFICATIONS

Enclosure Size: H27cm x W15cm x D10cm

Enclosure Type: UL Listed Polycarbonate (black)

Primary Conduit Entry: (2) 1/2" - 3/4" ports, (2) 3/4" ports

Secondary Conduit Entry: (2) 1/2" - 3/4" ports, (2) 3/4" ports

Overload Protection: Replaceable 10A blade fuse.

Model	Input 60 Hz.	Secondary Output	
		Lamp Watts (W)*	Voltage (VAC)
LIT YARD 4X	110 VAC	100 Max.	12 / 13.5

* Any combination of bulbs, any output.

TECHNICAL SPECIFICATION

RECEIVER RATING

Input: 110VAC ~ 60Hz

Output: 110VAC ~ 60Hz switched

Max. Load: 100W MAX. TOTAL

REMOTE

Battery: 2 x 'AAA'

Range: Up to 50m - line of sight

Freq: 915MHz ISM Band



NOTE

PLEASE STORE THIS
MANUAL IN A SAFE PLACE
FOR FUTURE REFERENCE

 **Spa Electrics®**

© COPYRIGHT 2021 SPA ELECTRICS
ALL RIGHTS RESERVED